

CATÁLOGO

Linhas Inox e Alumínio



www.jamaccessoriosparacorrir.com.br



SE GU RAN ÇA

SE
GU
RAN
ÇA

Com tranquilidade e conscientização, a segurança fica em nossas mãos.



04 A Empresa

05 Linha Acessórios Alumínio

06 Linha Conexão

10 Linha Acabamento

11 Linha Fixação

12 Linha Interligação

13 Fixação Vidro

15 Linha Fixação de Parede e Coluna Vidro

18 Linha Fixação Quadrada e Redonda

17 Fixação de Vidro

19 Linha Inox

26 Linha Puxadores e Kit Box

29 Contatos

ÍNDICE



A **Jam Ferragens** é uma empresa especializada em corrimão para escada, guarda-corpo e acessórios para corrimão em aço inox e alumínio. Localizada em São Paulo capital, a empresa nasceu em 2015 com foco na venda de acessórios para corrimão de alumínio. Com o passar do tempo, vimos a necessidade de fornecer novos produtos e serviços especializados para atender por completo as demandas dos nossos clientes!

Aqui na Jam você pode contar com uma equipe especializada em projetos personalizados (desenvolvimento e instalação) de corrimão e guarda-corpo e com um vasto estoque de peças e acessórios. Materiais de excelente qualidade com preço justo para a segurança da sua casa, loja ou indústria!

Nossa equipe preza sempre pelo bom atendimento e está à sua disposição!

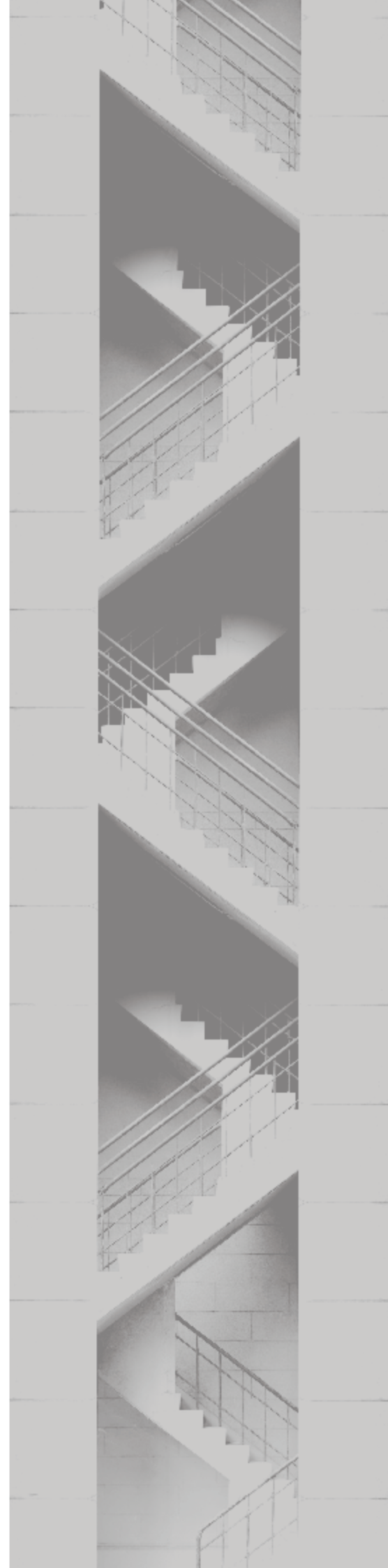

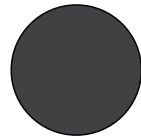

LINHA ALUMÍNIO

Conexões, canoplas, torres, suportes, bottons e outros acessórios em alumínio para seu corrimão. Diferentes tamanhos para atender sua necessidade e diferentes acabamentos: cromado, branco, preto, fosco e bronze.

LINHA CONEXÕES



BASE COM PRESILHA

DESCRIÇÃO
50MM / CÓD.Jr2050



BASE COM PRESILHA

DESCRIÇÃO
38MM / CÓD.JR2038



BASE COM PRESILHA

DESCRIÇÃO
25MM / CÓD.JR2025



KIT ANGULAR 50MM

DESCRIÇÃO
50MM / CÓD.JR5055



CORES DISPONÍVEIS

BRANCO | BRONZE | CROMADO | FOSCO | PRETO

LINHA CONEXÕES



KIT ANGULAR 25MM

DESCRIÇÃO

TUBO 25MM / CÓD. Jr5025
PAREDE 25MM / CÓD. Jr5026



BASE FIXA

DESCRIÇÃO

50MM / CÓD.JR3150



BASE COM LUVA

DESCRIÇÃO

50MM / CÓD Jr3450

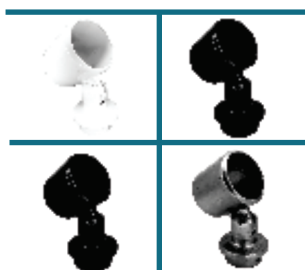

BASE COM LUVA

DESCRIÇÃO

38MM / CÓD.JR3438



CORES DISPONÍVEIS

BRANCO | BRONZE | CROMADO | FOSCO | PRETO

LINHA CONEXÕES



UNIÃO 50MM

DESCRIÇÃO
50MM / CÓD. Jr2850

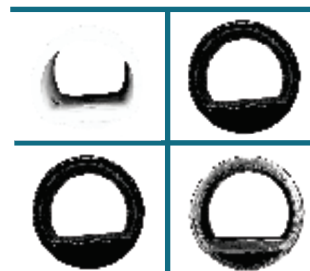

UNIÃO 38MM REDONDO

DESCRIÇÃO
38MM / CÓD Jr2851



COTOVELO TRIPLO FIXO

DESCRIÇÃO
50MM / CÓD Jr3250

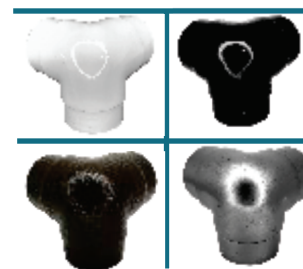

CORES DISPONÍVEIS
BRANCO | BRONZE | CROMADO | FOSCO | PRETO

LINHA ACABAMENTO



TAMPA LATERAL EXTERNA

DESCRIÇÃO

25MM / CÓD Jr2225
38MM / CÓD Jr2238
50MM / CÓD Jr2251



TAMPA LATERAL RETA INTERNA

DESCRIÇÃO

50MM / CÓD Jr2232
38MM / CÓD Jr5038

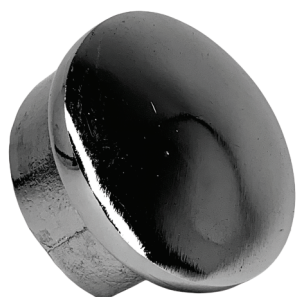

TAMPA LATERAL INTERNA

DESCRIÇÃO

50MM / CÓD.JR2231

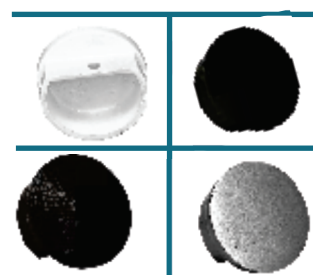

CORES DISPONÍVEIS

BRANCO | BRONZE | CROMADO | FOSCO | PRETO

LINHA ACABAMENTO



TAMPA LATERAL TARTARUGA

DESCRIÇÃO
50MM / CÓD. Jr2250

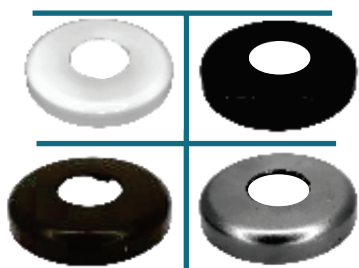
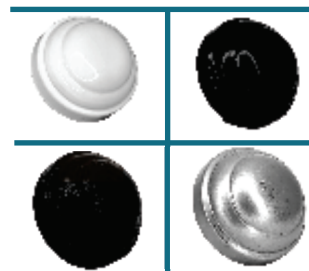

CANOPLA RETA

DESCRIÇÃO
38MM / CÓD.Jr3138
50MM / CÓD.Jr2139

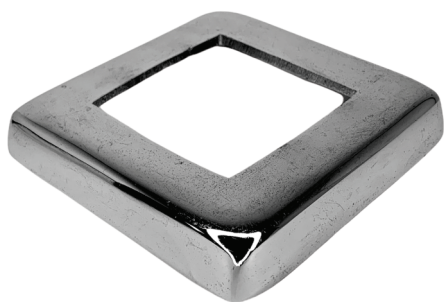

CANOPLA QUADRADA

DESCRIÇÃO
50X50MM / CÓD Jr6070

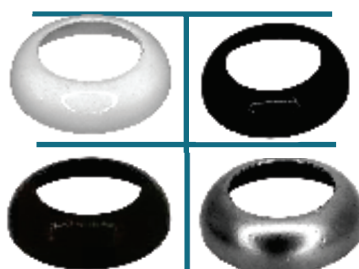
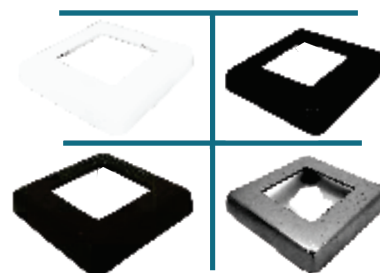

CANOPLA ABAULADA

DESCRIÇÃO
50MM / CÓD.JR6170



CORES DISPONÍVEIS
BRANCO | BRONZE | CROMADO | FOSCO | PRETO

LINHA FIXAÇÃO



CONJ. PASSA BARRA PASSANTE

DESCRIÇÃO
16MM / CÓD Jr5080



CONJ. PASSA B. NÃO PASSANTE

DESCRIÇÃO
16MM / CÓD Jr5081 DIR.



SUPOORTE LATERAL

DESCRIÇÃO
50MM / CÓD.JR8050



SUPOORTE ARTICULADO

DESCRIÇÃO
50MM / CÓD.JR1003



CORES DISPONÍVEIS

BRANCO | BRONZE | CROMADO | FOSCO | PRETO

LINHA INTERLIGAÇÃO



COTOVELO ARTICULADO

DESCRIÇÃO

50MM / CÓD JR2650
38MM / CÓD JR2638



COTOVELO DUPLO ARTICULADO

DIREITO E ESQUERDO

DESCRIÇÃO

50MM / CÓD.JR5070



COTOVELO TRIPLO MÓVEL

DESCRIÇÃO

50MM / CÓD.JR3350

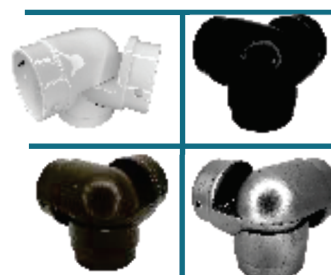

COTOVELO ARTICULADO

DESCRIÇÃO

16MM / CÓD.JR2558



CORES DISPONÍVEIS

BRANCO | BRONZE | CROMADO | FOSCO | PRETO

LINHA FIXAÇÃO DE VIDRO

PINÇA QUADRADA

DESCRIÇÃO

CÓD Jr5060

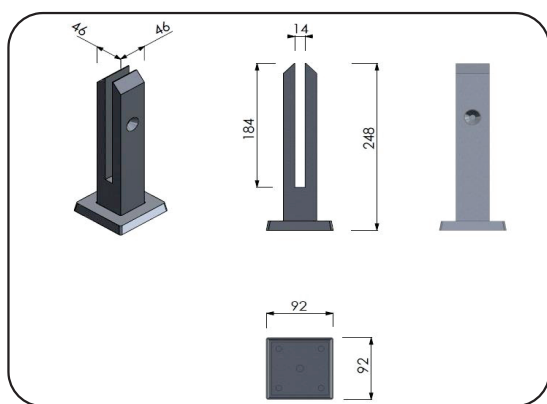

PINÇA REDONDA

DESCRIÇÃO

CÓD. Jr5065

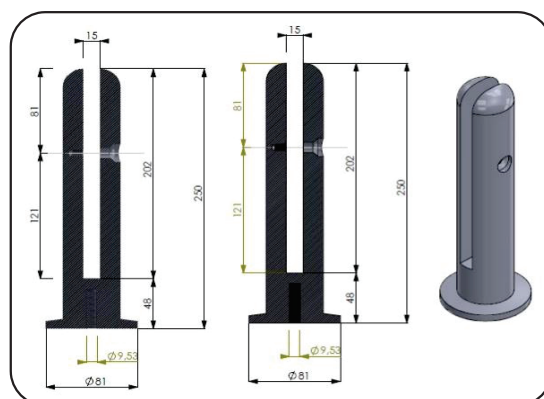

CORES DISPONÍVEIS

BRANCO | BRONZE | CROMADO | FOSCO | PRETO

LINHA FIXAÇÃO DE VIDRO

PRESILHA DE VIDRO

DESCRIÇÃO

CÓD. Jr2538

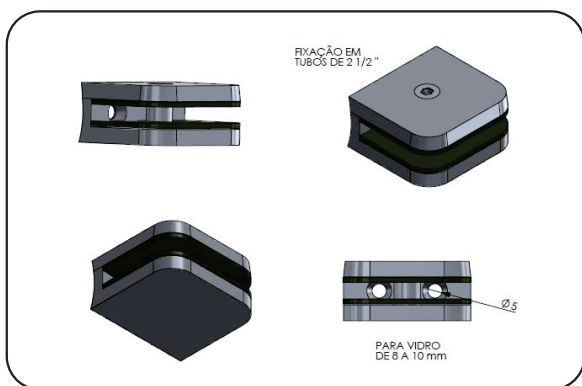

PRESILHA DE VIDRO DE PRESSÃO

DESCRIÇÃO

CÓD. Jr2537

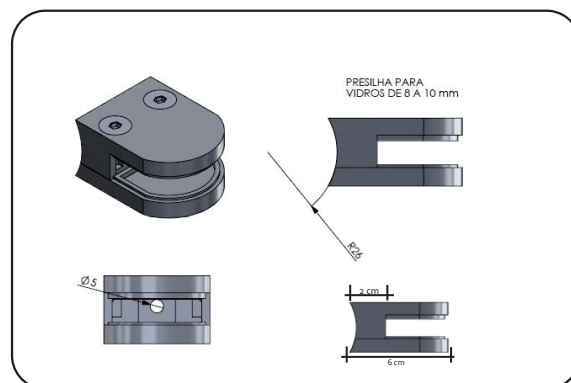

CORES DISPONÍVEIS
BRANCO | BRONZE | CROMADO | FOSCO | PRETO

LINHA FIXAÇÃO DE PAREDE E COLUNA DE VIDRO



SUPORE DE PAREDE

DESCRIÇÃO

50MM / CÓD. JR3050

38MM / CÓD. Jr3038

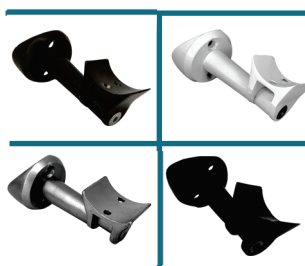

SUPORE DEFICIENTE

DESCRIÇÃO

38MM/ CÓD. Jr 3052

50MM/ CÓD. Jr 3051



SUP. FIXAÇÃO DE VIDRO

DESCRIÇÃO

38MM/ CÓD. Jr 3037

50MM/ CÓD. Jr 3032

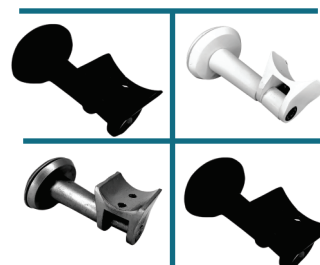

CORES DISPONÍVEIS

BRANCO | BRONZE | CROMADO | FOSCO | PRETO

LINHA FIXAÇÃO DE PAREDE E COLUNA DE VIDRO



CURVA C/ FLANGE

DESCRIÇÃO
38MM/ CÓD. Jr 3538



CURVA 90°

DESCRIÇÃO
50MM / CÓD. Jr2750



CURVA 90°

DESCRIÇÃO
38MM / CÓD. Jr2738

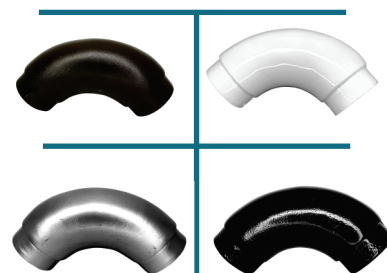

CURVA COM FLANGE

DESCRIÇÃO
50MM / CÓD. Jr 3550



CORES DISPONÍVEIS

BRANCO | BRONZE | CROMADO | FOSCO | PRETO

LINHA FIXAÇÃO DE PAREDE E COLUNA DE VIDRO



SUP. TRADICIONAL REDONDO

DESCRIÇÃO
CÓD. JR9011



SUP. TRADICIONAL RETO

DESCRIÇÃO
CÓD. JR9010



CORES DISPONÍVEIS

BRANCO | BRONZE | CROMADO | FOSCO | PRETO

LINHA FIXAÇÃO REDONDA E QUADRADA

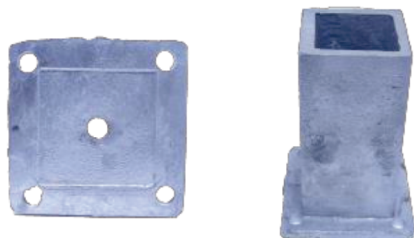

PÉ DE ALUMÍNIO QUADRADO

DESCRIÇÃO 50X50MM
50MM / CÓD Jr2957
250 ALTURA

PÉ DE ALUMÍNIO

DESCRIÇÃO 50X50MM
50MM / CÓD Jr2955
200 ALTURA

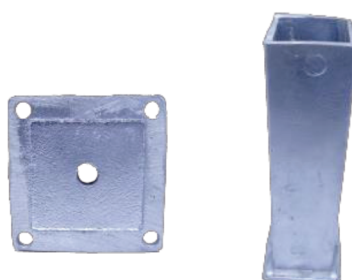

PÉ DE ALUMÍNIO REDONDO

DESCRIÇÃO 50MM
50MM / CÓD Jr2951
200 ALTURA



PÉ DE ALUMÍNIO

DESCRIÇÃO 50MM
50MM / CÓD Jr2950
150 ALTURA



PÉ DE ALUMÍNIO REDONDO

DESCRIÇÃO
50MM / CÓD Jr2952
50 ALTURA

CORES DISPONÍVEIS
ALUMÍNIO NATURAL

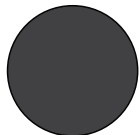

LINHA INOX

Curvas, suportes, presilhas, torres e outros acessórios para corrimão em acabamento aço inox. Diferentes tamanhos para atender sua necessidade.

LINHA INOX



CONEXÃO COM LUVA

CÓD	MEDIDA
RG 01	A- 2"POL
RG 02	B- 1 1/2 POL

DESCRIÇÃO

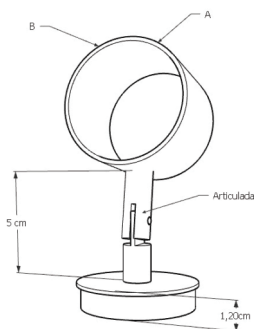
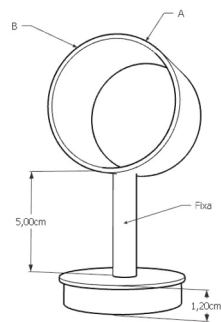

CONEXÃO C/ ARTICULADA

CÓD	MEDIDA
RG 03	A- 2"POL
RG 04	B- 1 1/2 POL

DESCRIÇÃO



CONEXÃO C/ PINO FIXO

CÓD	MEDIDA
RG 05	A- 2"POL
RG 06	B- 1 1/2 POL
RG 07	Tudo Quadrado

DESCRIÇÃO

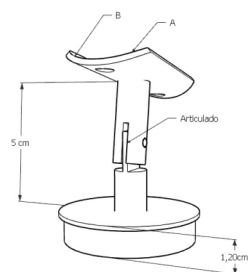
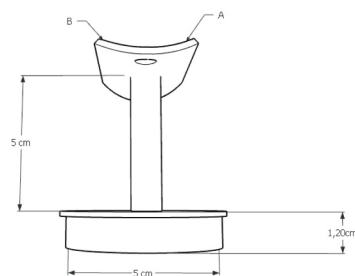

CONEXÃO C/ PINO ARTICULADO

CÓD	MEDIDA
RG 08	A- 2"POL
RG 09	B- 1 1/2 POL
RG 10	Tudo Quadrado

DESCRIÇÃO



CORES DISPONÍVEIS

INOX | BRANCO | BRONZE | CROMADO | FOSCO | PRETO

LINHA INOX

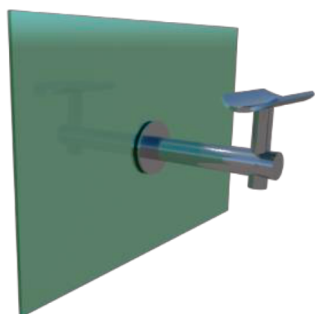

SUP. DE VIDRO C/ REGULAGEM

CÓD	MEDIDA
RG 11	A- 2"POL
RG 12	B- 1 1/2 POL
RG 13	Tudo Quadrado

DESCRIÇÃO

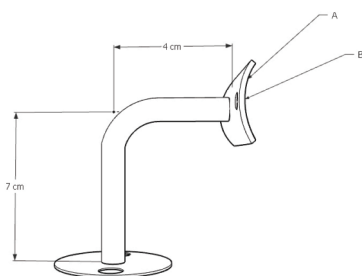
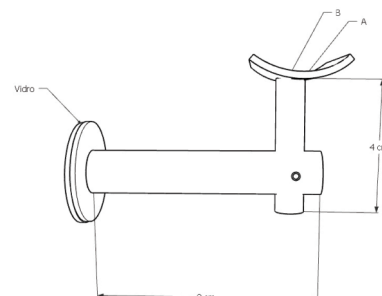

SUPORTE PAREDE FIXA

CÓD	MEDIDA
RG 14	A- 2"POL
RG 15	B- 1 1/2 POL
RG 16	Tudo Quadrado

DESCRIÇÃO

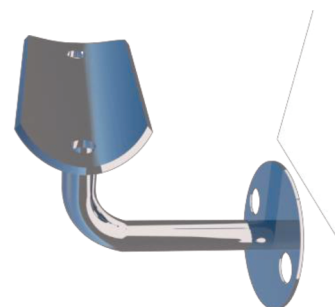

SUPORTE DE PAREDE C/ LUVA

CÓD	MEDIDA
RG 17	A- 2"POL
RG 18	B- 1 1/2 POL

DESCRIÇÃO

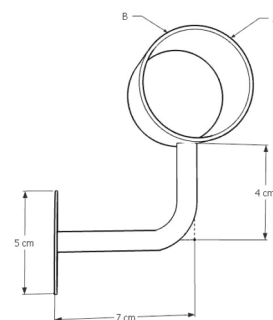

TAMPA DE ACABAMENTO INTERNO

CÓD	MEDIDA
RG 19	A- 2"POL
RG 20	B- 1 1/2 POL

DESCRIÇÃO

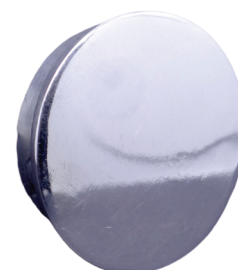

CORES DISPONÍVEIS

INOX | BRANCO | BRONZE | CROMADO | FOSCO | PRETO

LINHA INOX



UNIÃO VIDRO E VIDRO RETO

CÓD
RG 21

DESCRIÇÃO
MEDIDA
RETO

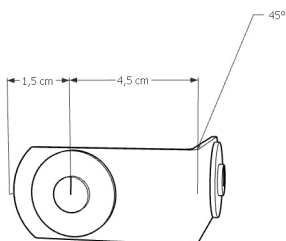
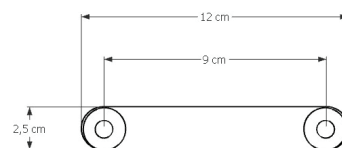

UNIÃO VIDRO E VIDRO 45

CÓD
RG 22

DESCRIÇÃO
MEDIDA
45

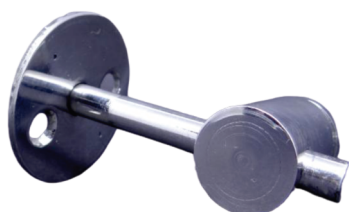

UNIÃO VIDRO E ALVENARIA

COM REGULAGEM

CÓD
RG 23

DESCRIÇÃO
MEDIDA
REGULAGEM

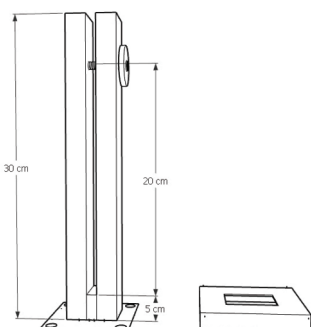
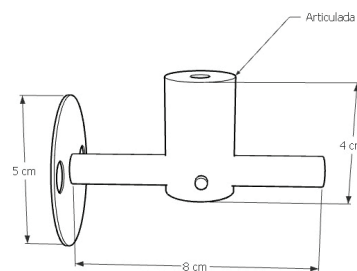

TORRE DE INOX 30/ COM 1 FURO

CÓD
RG 24

DESCRIÇÃO
MEDIDA
300MM



CORES DISPONÍVEIS

INOX | BRANCO | BRONZE | CROMADO | FOSCO | PRETO

LINHA INOX



TORRE INOX 30/ COM 2 FUROS

DESCRIÇÃO	
CÓD	MEDIDA
RG 25	300MM

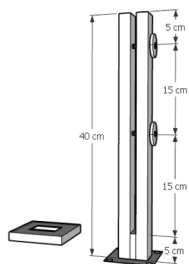
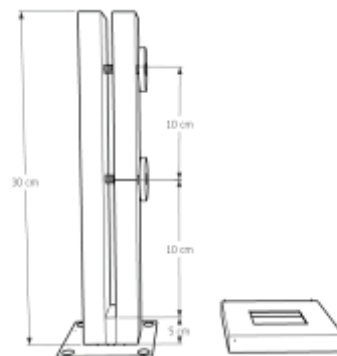

TORRE DE INOX 40/ COM 2 FUROS

DESCRIÇÃO	
CÓD	MEDIDA
RG 26	400MM



TORRE INOX

DESCRIÇÃO	
CÓD	MEDIDAS
RG 27	H 20CM
RG 28	H 60CM
RG 29	H 80CM

SOB MEDIDA

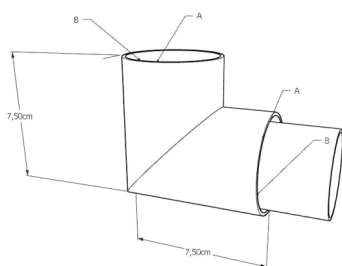
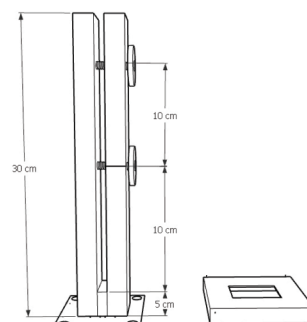

COTOVELO FIXO 45°

DESCRIÇÃO	
CÓD	MEDIDA
RG 30	A- 2"POL
RG 31	B- 1 1/2 POL
RG 32	5/8 POL

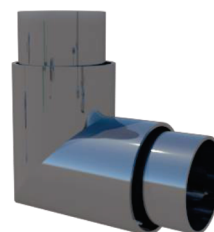

CORES DISPONÍVEIS

INOX | BRANCO | BRONZE | CROMADO | FOSCO | PRETO

LINHA INOX

ALUMÍNIO COM
CORPO EM INOX

BOTTON DE ALUMÍNIO

DESCRIÇÃO

38MM / CÓD.JR2539

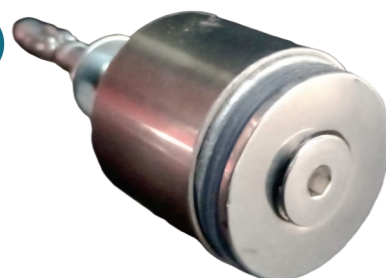

PROLONGADOR MACIÇO

DESCRIÇÃO

CÓD
RG 33

PASSA BARRA

DESCRIÇÃO

CÓD MEDIDA
RG 34 5/8 POL



CANOPLA

DESCRIÇÃO

CÓD MEDIDA
RG 36 A- 2"POL
RG 37 B- 1 1/2 POL



CORES DISPONÍVEIS
INOX

LINHA INOX



JUNÇÃO PERFIL U 45°

DESCRIÇÃO

CÓD
RG 62

ALUMÍNIO COM
CORPO EM INOX

PERFIL U 3MT

DESCRIÇÃO

CÓD
RG 60

MEDIDA
3M



JUNÇÃO PERFIL U RETO

DESCRIÇÃO

CÓD
RG 61



CORES DISPONÍVEIS
INOX

JAM
INDUSTRIAS

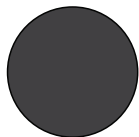

LINHA
PUXADOR
KIT BOX

LINHA PUXADOR E KIT BOX



PUXADOR H 40X20

CÓD	MEDIDA
RG 38	400X300
RG 39	600X500
RG 40	1000X800
RG 41	800X600

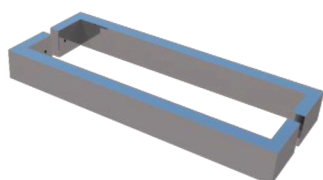
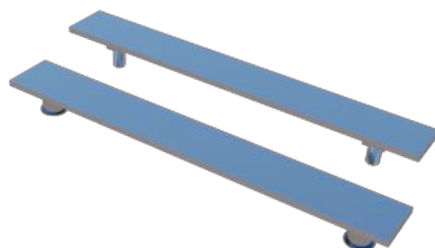

UNIÃO VIDRO E VIDRO 45°

CÓD	MEDIDA
RG 42	600
RG 43	800
RG 44	1000
RG 45	1200



PUXADOR FINO U 40X20

CÓD	MEDIDA
RG 46	600
RG 47	800
RG 48	1000
RG 49	1200



PUXADOR H REDONDO 1 1/2 POL

CÓD	MEDIDA
RG 50	600X400
RG 51	800X600
RG 52	1000X800
RG 53	1200X1000

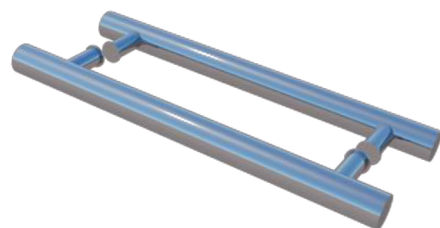

CORES DISPONÍVEIS
INOX

LINHA PUXADOR E KIT BOX

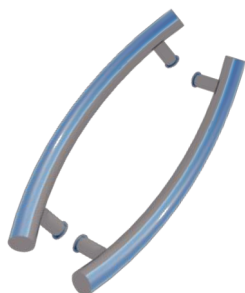

PUXADOR H REDONDO 1 1/2 POL

DESCRIÇÃO

CÓD	MEDIDA
RG 54	600X400
RG 55	800X600
RG 56	1000X800
RG 57	1200X1000

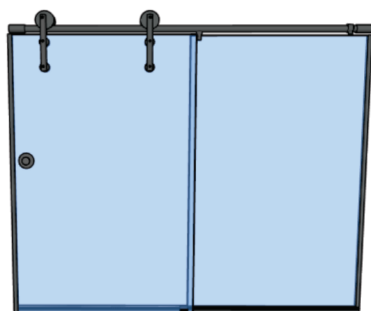

KIT BOX

DESCRIÇÃO

CÓD	MEDIDA
RG 38	1500X1900
RG 55	2000X1900

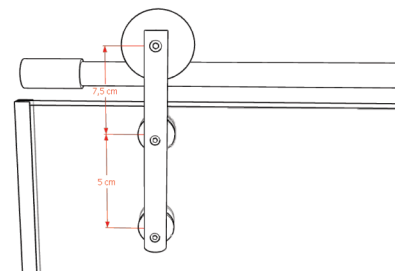

TODOS OS ACESSÓRIOS SÃO
PADRONIZADOS PARA TUDO DE
50 MM, 38MM E 25MM X 1.2 DE
ESPESSURA

PARAFUSOS EM AÇO INOX



CORES DISPONÍVEIS
INOX



Segurança aliada
à estética para
proteger e agradar
todos os gostos
e estilos!

CONTATOS



11 94757-1464



11 2747-5377



11 2747-1907



www.jamaccessoriosparacorrimeo.com.br



@jamferragensaccessorios



@jamferragensaccessorios